

# TA16

series



## Product Segments

- **Care Motion**
- **Comfort Motion**
- **Ergo Motion**
- **Industrial Motion**

TiMOTION's TA16 series linear actuator is similar to the TA2 linear actuator, but is specifically designed for low-noise applications where a compact linear actuator is needed. It is available with optional IP66 protection and Hall sensors for position feedback. Certificates for the TA16 include IEC60601-1, ES60601-1, IEC60601-1-2, UL962, and EMC.

### General Features

Max. load	4,500N (push) ; 2,500N (pull)
Max. speed at max. load	4.9mm/s
Max. speed at no load	56.5mm/s
Retracted length	≥ Stroke + 112mm
IP rating	IP66M
Certificate	IEC60601-1, ES60601-1, IEC60601-1-2, UL962, EMC
Stroke	20~600mm
Output signals	Mechanical Pot., NPN Hall sensors, PNP Hall sensors
Options	Motor brake
Voltage	12/24/36/48V DC; 12/24/48V DC (PTC)
Color	Silver
Operational temperature range at full performance	+5°C~+45°C
With very low noise, small size for easy installation	
Suitable for patient hoist application	

**Drawing**

Dimensions  
without Output Signal  
or with Hall Sensors  
(mm)

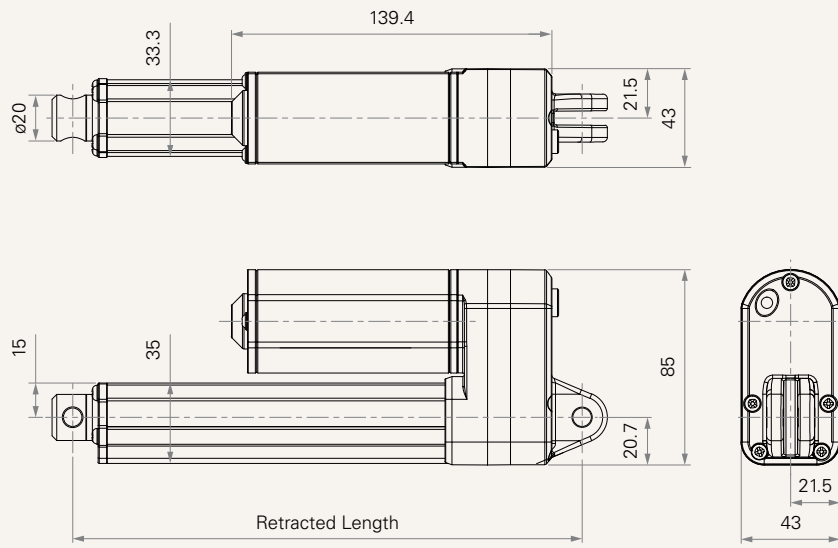

Dimensions with POT  
(mm)

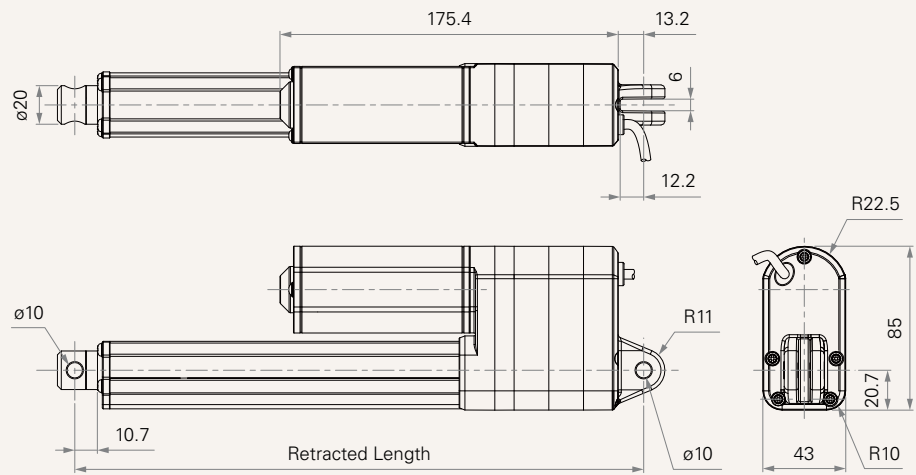

## Load and Speed

CODE	Load (N)		Self Locking Force (N)	Typical Current (A)		Typical Speed (mm/s)	
	Push	Pull		No Load 32V DC	With Load 24V DC	No Load 32V DC	With Load 24V DC
<b>Motor Speed (3800RPM, Duty Cycle 10%)</b>							
<b>A</b>	2500	2500	2500	1.7	2.4	5.2	3.0
<b>B</b>	2000	2000	2000	1.7	2.4	8.3	4.7
<b>C</b>	1500	1500	1500	1.7	2.2	10.8	7.0
<b>D</b>	1000	1000	1000	1.7	2.4	17.1	10.0
<b>E</b>	500	500	500	1.7	2.8	56.5	28.0
<b>Motor Speed (5200RPM, Duty Cycle 10%)</b>							
<b>G</b>	3500	2500	3500	2.0	4.7	11.0	6.2
<b>J</b>	2000	2000	2000	2.0	3.7	15.8	9.5
<b>K</b>	1500	1500	1500	2.0	3.7	21.5	14.2
<b>L</b>	4500	2500	4500	2.0	5.0	9.5	4.9

### Note

- 1 #G\_When pull load > 2500N, please discuss with engineer.
- 2 Please refer to the approved drawing for the final authentic value.
- 3 This self-locking force level is reached only when a short circuit is applied on the terminals of the motor. All the TiMOTION control boxes have this feature built-in. The self-locking force is a minimum value and can be actually higher.
- 4 The current & speed in table are tested with 24V DC motor. With a 12V DC motor, the current is approximately twice the current measured in 24V DC. With a 36V DC motor, the current is approximately two-thirds the current measured in 24V DC. With a 48V DC motor, the current is approximately half the current measured in 24V DC. Speed will be similar for all the voltages.
- 5 The current & speed in table is tested when the actuator is extending under push load
- 6 The current & speed in table and diagram are tested with TiMOTION control boxes, and there will be around 10% tolerance depending on different models of the control box. (Under no load condition, the voltage is around 32V DC. At rated load, the voltage output will be around 24V DC)
- 7 Without load, noise level ≤ 56dBA (by TiMOTION test standard, ambient noise level ≤ 36dBA).
- 8 Standard stroke: Please refer to the table below.

CODE	Load (N)	Min Stroke (mm)	Max Stroke (mm)
<b>E</b>	≤ 500	38	600
<b>D</b>	≤ 1000	20	600
<b>C, K</b>	≤ 1500	20	500
<b>B, J</b>	≤ 2000	20	450
<b>A</b>	≤ 2500	20	400
<b>G</b>	≤ 3500	20	300
<b>L</b>	≤ 4500	20	300

**Performance Data (24V DC Motor)**

Motor Speed (3800RPM, Duty Cycle 10%)

Speed vs. Load

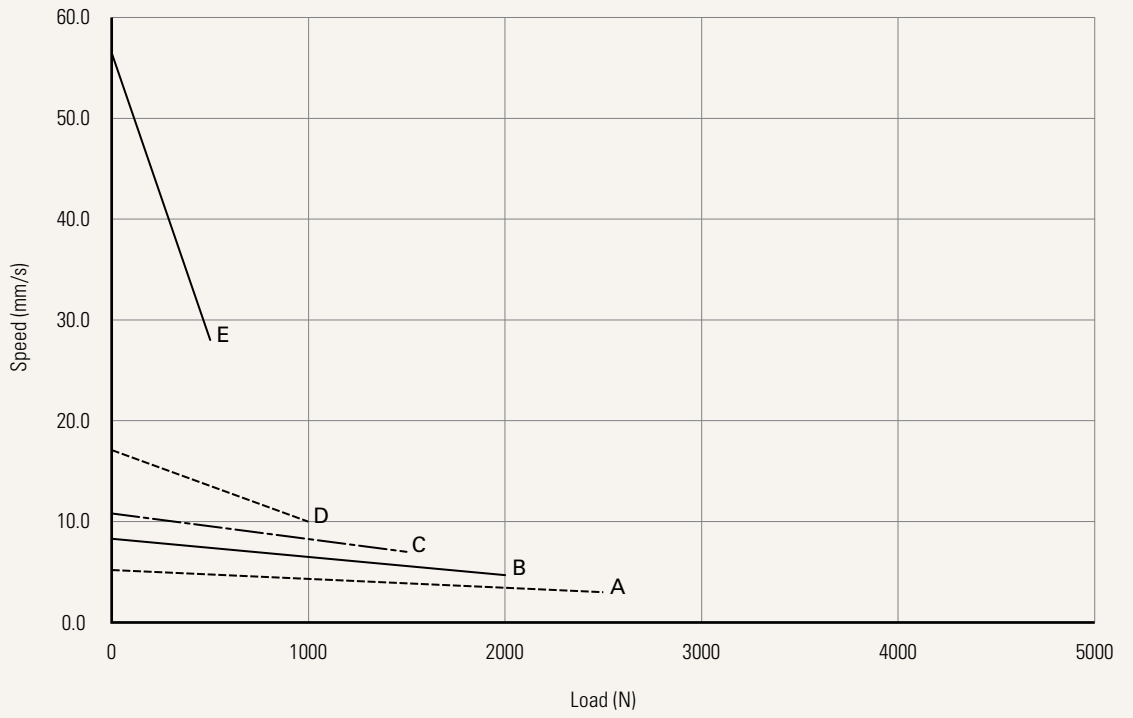

Current vs. Load

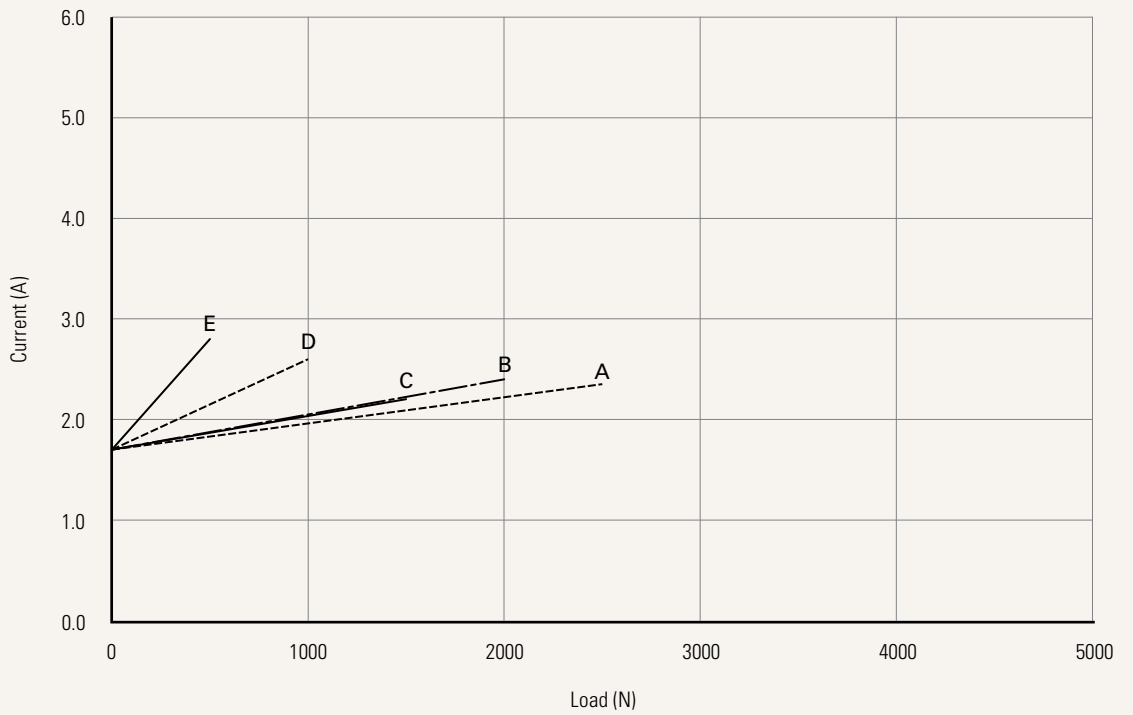

**Performance Data (24V DC Motor)**

Motor Speed (5200RPM, Duty Cycle 10%)

Speed vs. Load

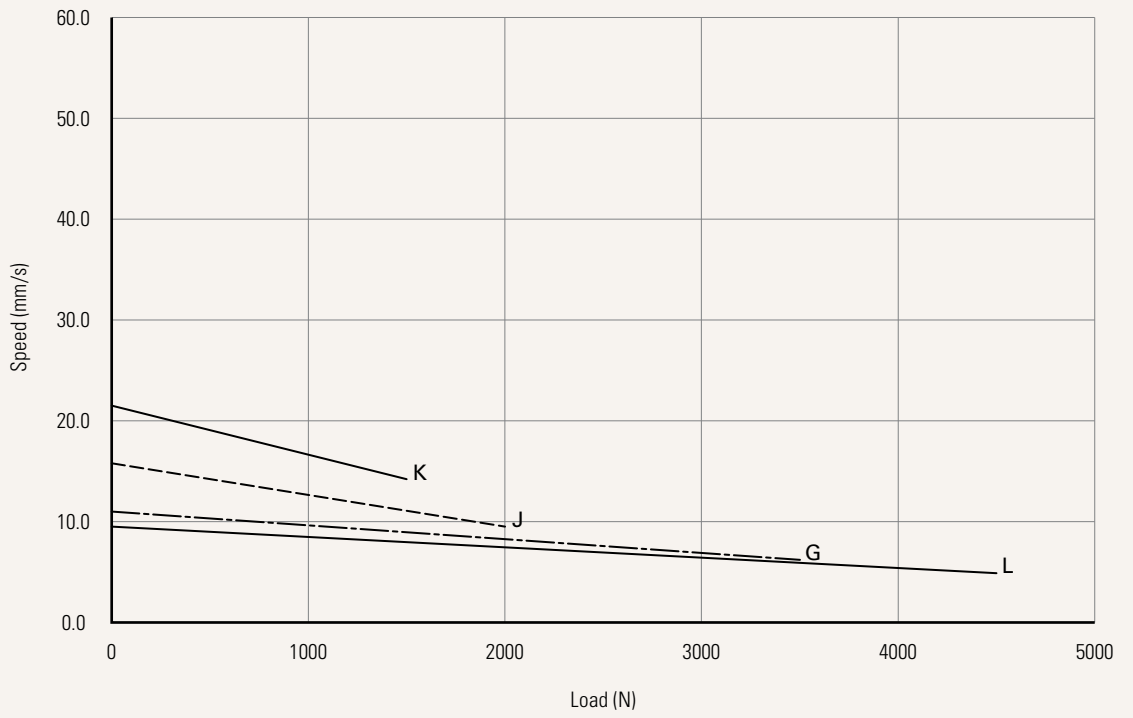

Current vs. Load

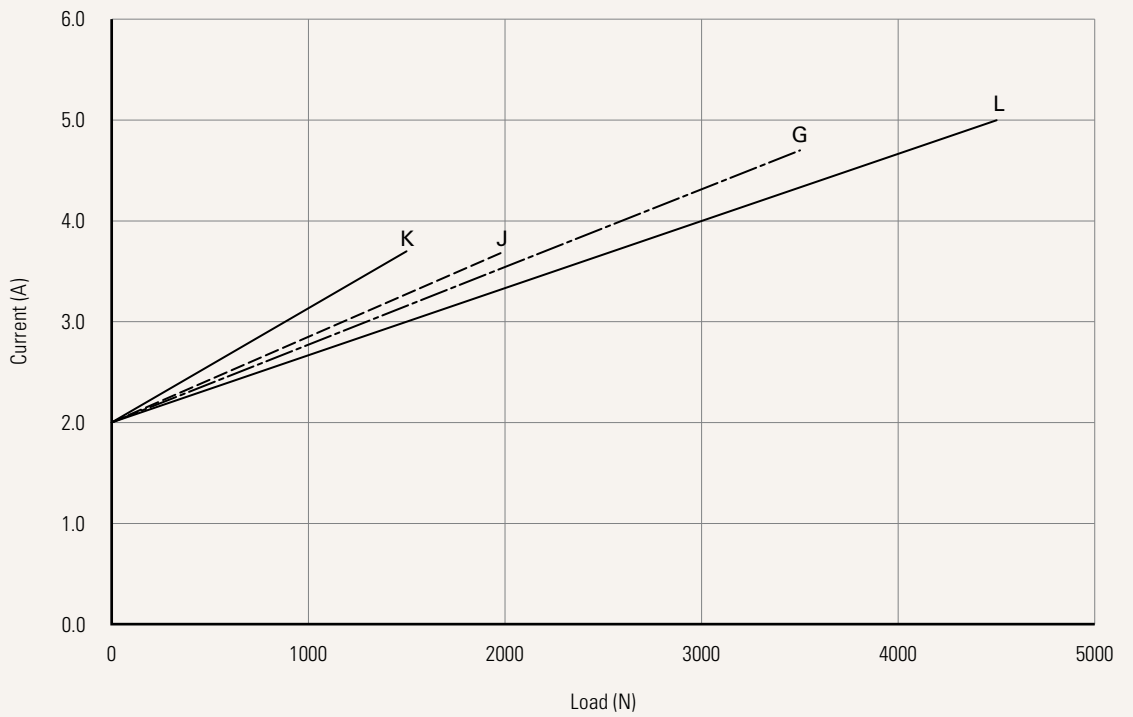

<b>Voltage</b>	1 = 12V DC 2 = 24V DC	3 = 36V DC 4 = 48V DC	5 = 24V DC, PTC 6 = 12V DC, PTC	8 = 48V DC, PTC
<b>Load and Speed</b>	<a href="#">See page 3</a>			
<b>Stroke (mm)</b>	<a href="#">See page 3</a>			
<b>Retracted Length (mm)</b>	<a href="#">See page 7</a>			
<b>Rear Attachment (mm)</b> <a href="#">See page 8</a>	1 = Aluminum, U clevis, width 6.0, depth 12.2, hole 6.4, one piece casting with gearbox 2 = Aluminum, U clevis, width 6.0, depth 12.2, hole 8.0, one piece casting with gearbox 3 = Aluminum, U clevis, width 6.0, depth 12.2, hole 10.0, one piece casting with gearbox B = Aluminum, U clevis, width 6.0, depth 12.2, hole 10.2, one piece casting with gearbox, with plastic T-bushing (black), for weather resistant application			
<b>Front Attachment (mm)</b> <a href="#">See page 8</a>	1 = Aluminum, slotless, hole 6.4 2 = Aluminum, slotless, hole 8.0 3 = Aluminum, slotless, hole 10.0 4 = Aluminum, U clevis, width 6.0, depth 13.0, hole 6.4 5 = Aluminum, U clevis, width 6.0, depth 13.0, hole 8.0		6 = Aluminum, U clevis, width 6.0, depth 13.0, hole 10.0 B = Aluminum, slotless, hole 10.2, with plastic T-bushing (black), for weather resistant application C = Steel, U clevis, width 6.0, depth 13.0, hole 10.2, with plastic T-bushing (black), for weather resistant application	
<b>Direction of Rear Attachment (Counterclockwise)</b> <a href="#">See page 9</a>	1 = 90°		2 = 0°	
<b>IP Rating</b>	1 = Without 2 = IP54	3 = IP66 5 = IP66W	6 = IP66M	
<b>Function of Limit Switches</b> <a href="#">See page 9</a>	1 = Two micro switches cut off the actuator at end of stroke 2 = Two micro switches cut off the actuator at end of stroke + third one in between sends signal 3 = Two micro switches send signal at end of stroke 4 = Two micro switches send signal at end of stroke + third one in middle sends signal			
<b>Special Function of Spindle Set</b>	0 = Without (Standard) 1 = Safety nut		2 = Standard push only 3 = Standard push only + safety nut	
<b>Output Signal</b>	0 = Without 1 = Mechanical pot.	4 = Hall sensor*1 5 = Hall sensor*2	N = NPN Hall sensor*2 P = PNP Hall sensor*2	
<b>Connector</b> <a href="#">See page 9-10</a>	1 = DIN 6P, 90° plug 2 = Tinned leads 4 = Big 01P, plug	C = Y cable (For direct cut system, water proof, anti pull) E = Molex 8P, plug F = DIN 6P, 180° plug		G = Audio plug
<b>Cable Length (mm)</b>	0 = Straight, 100 1 = Straight, 500 2 = Straight, 750	3 = Straight, 1000 4 = Straight, 1250 5 = Straight, 1500	6 = Straight, 2000 7 = Curly, 200 8 = Curly, 400	B-H = For direct cut system <a href="#">See page 9</a>
<b>Brake</b>	0 = Without		1 = Motor brake	
<b>Load Type</b>	T = Push		P = Pull	
<b>Color</b>	0 = Silver grey 3 = Glittering black, for weather resistant application			

## Retracted Length (mm)

1. Calculate  $A+B+C+D+E = Y$
2. Retracted length needs to  $\geq$  Stroke + Y

### A. Rear / Front Attach.

Front Attach.	Rear Attach.
	1, 2, 3, B
<b>1, 2, 3</b>	+112
<b>B</b>	+115
<b>4, 5, 6, C</b>	+122

### B. Load V.S. Stroke

Stroke (mm)	Load & Speed Type	
	A, B, C, D, E, J, K	G, L
<b>20~150</b>	-	+13
<b>151~200</b>	+8	+21
<b>201~250</b>	+8	+21
<b>251~300</b>	+13	+26
<b>301~350</b>	+13	+26
<b>351~400</b>	+18	+31
<b>401~450</b>	+23	+36
<b>451~500</b>	+28	+41
<b>501~550</b>	+33	+46
<b>551~600</b>	+38	+51

### C. Load V.S. Spindle Functions

Spindle Functions	Load & Speed Type	
	A, B, C, D, E, J, K	G, L
<b>0</b>	-	-
<b>1</b>	+10	+5
<b>2</b>	+2	+2
<b>3</b>	+12	+7

### D. Output Signals

<b>0, 4, 5, N, P</b>	-
<b>1</b>	+36

## Rear Attachment (mm)

1 = Aluminum, U clevis, width 6.0, depth 12.2, hole 6.4, one piece casting with gearbox

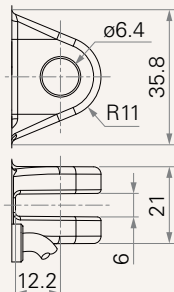

2 = Aluminum, U clevis, width 6.0, depth 12.2, hole 8.0, one piece casting with gearbox

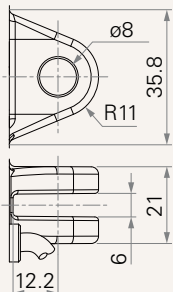

3 = Aluminum, U clevis, width 6.0, depth 12.2, hole 10.0, one piece casting with gearbox

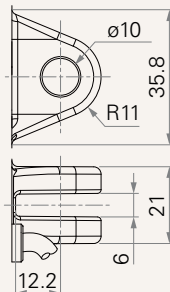

B = Aluminum, U clevis, width 6.0, depth 12.2, hole 10.2, one piece casting with gearbox, with plastic T-bushing (black), for weather resistant application

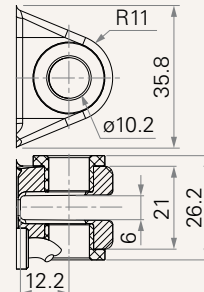

## Front Attachment (mm)

1 = Aluminum, slotless, hole 6.4

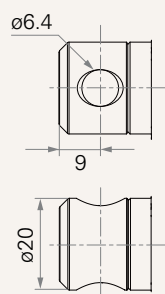

2 = Aluminum, slotless, hole 8.0

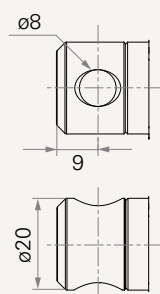

3 = Aluminum, slotless, hole 10.0

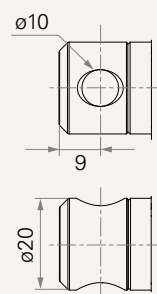

4 = Aluminum, U clevis, width 6.0, depth 13.0, hole 6.4

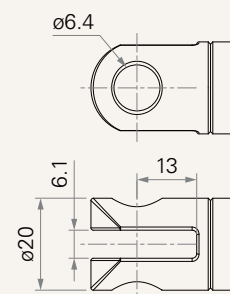

5 = Aluminum, U clevis, width 6.0, depth 13.0, hole 8.0

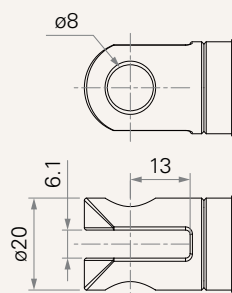

6 = Aluminum, U clevis, width 6.0, depth 13.0, hole 10.0

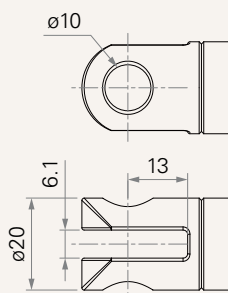

B = Aluminum, slotless, hole 10.2, with plastic T-bushing (black), for weather resistant application

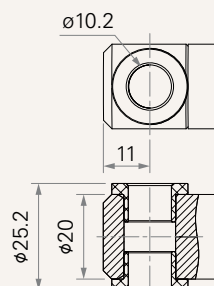

C = Steel, U clevis, width 6.0, depth 13.0, hole 10.2, with plastic T-bushing (black), for weather resistant application

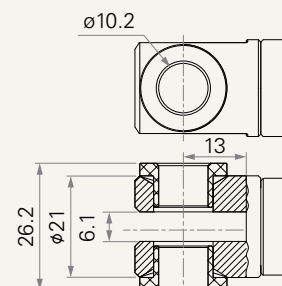



## Direction of Rear Attachment (Counterclockwise)

1 = 90°

2 = 0°

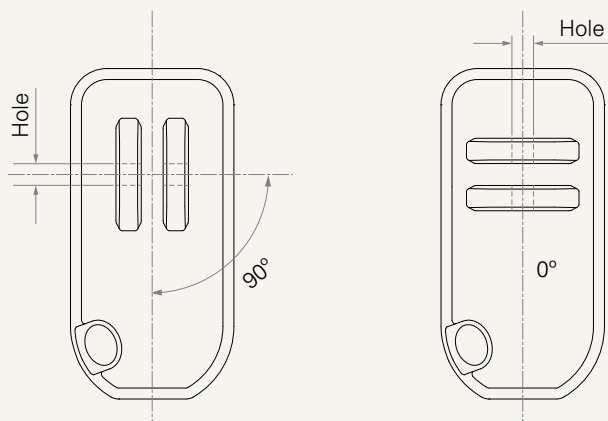

## Function of Limit Switches

### Wire Definitions

CODE	Pin					
	● 1 (Green)	● 2 (Red)	○ 3 (White)	● 4 (Black)	● 5 (Yellow)	● 6 (Blue)
1	extend (VDC+)	N/A	N/A	N/A	retract (VDC+)	N/A
2	extend (VDC+)	N/A	middle switch pin B	middle switch pin A	retract (VDC+)	N/A
3	extend (VDC+)	common	upper limit switch	N/A	retract (VDC+)	lower limit switch
4	extend (VDC+)	common	upper limit switch	medium limit switch	retract (VDC+)	lower limit switch

## Connector

1 = DIN 6P, 90° plug

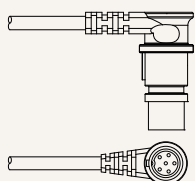

2 = Tinned leads

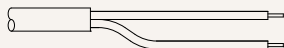

4 = Big 01P, plug

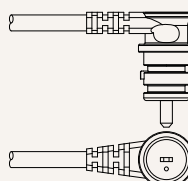

C = Y cable (For direct cut system, water proof, anti pull)

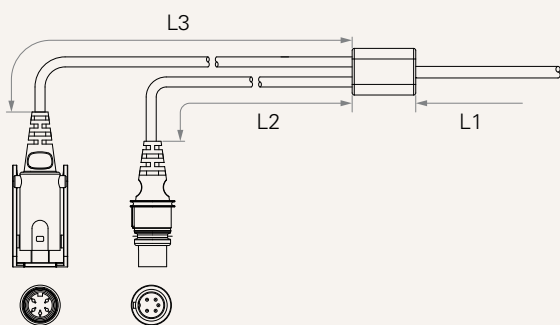

### Cable Length for Direct Cut System (mm)

CODE	L1	L2	L3
B	100	100	100
C	100	1000	400
D	100	2700	500
E	1000	100	100
F	100	600	1000
G	1500	1000	1000
H	100	100	1200

---

## Connector

E = Molex 8P, plug

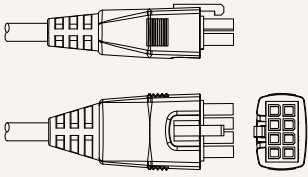

F = DIN 6P, 180° plug

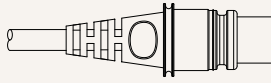

G = Audio plug



---

## Terms of Use

The user is responsible for determining the suitability of TiMOTION products for a specific application. TiMOTION products are subject to change without prior notice.